

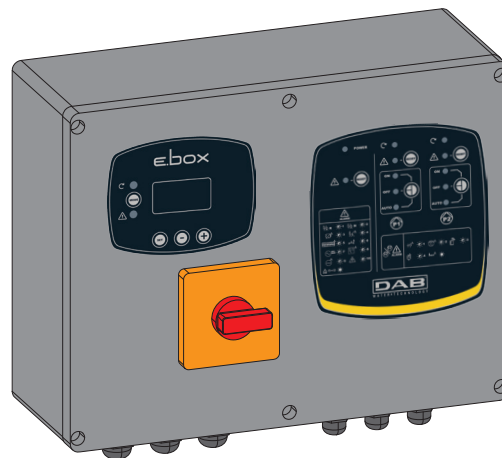

max 50°C  
min 0°C



## QUICK GUIDE E.BOX



[www.dabpumps.com/qrcode/60172355\\_OM\\_EBOX.pdf](http://www.dabpumps.com/qrcode/60172355_OM_EBOX.pdf)

## **GENERAL INSTRUCTIONS / INSTRUZIONI GENERALI**

**Pag. 1 - 6**



**DRAINAGE WITH FLOAT SWITCH / DRENAGGIO CON GALLEGGIANTE**

**Pag. 7**



**FILLING WITH FLOAT SWITCH / RIEMPIMENTO CON GALLEGGIANTE**

**Pag. 12**



**BOOSTER WITH SENSOR / PRESSURIZZAZIONE CON SENSORE**

**Pag. 17**

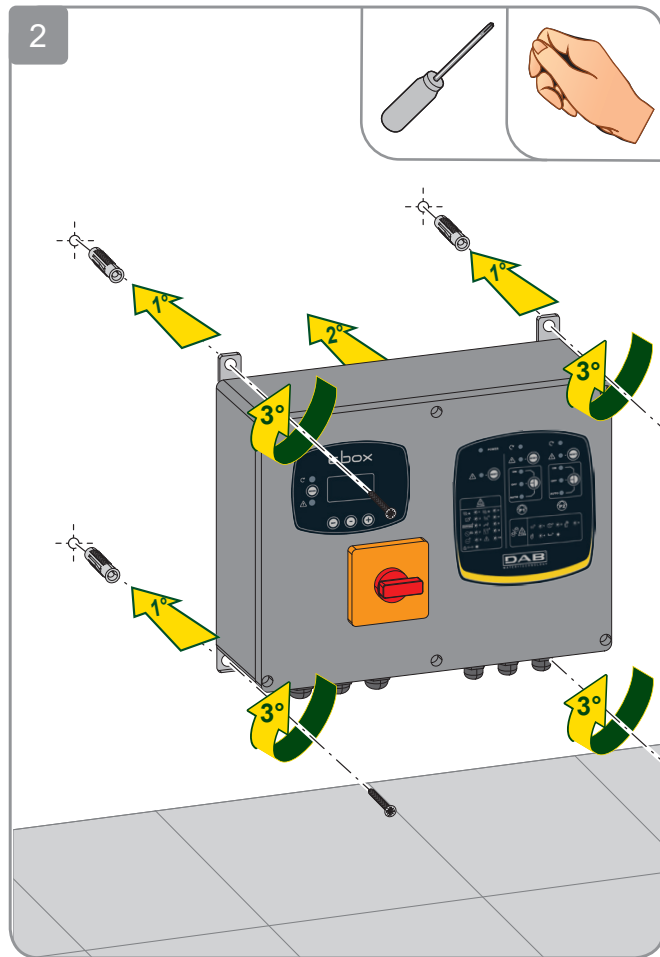
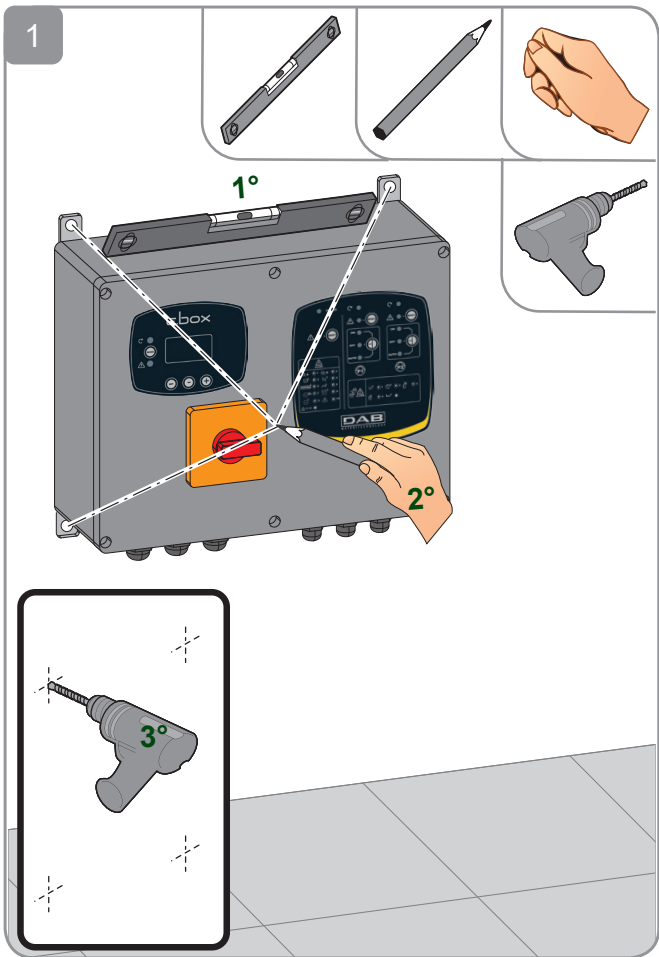

3a

# E.Box Basic

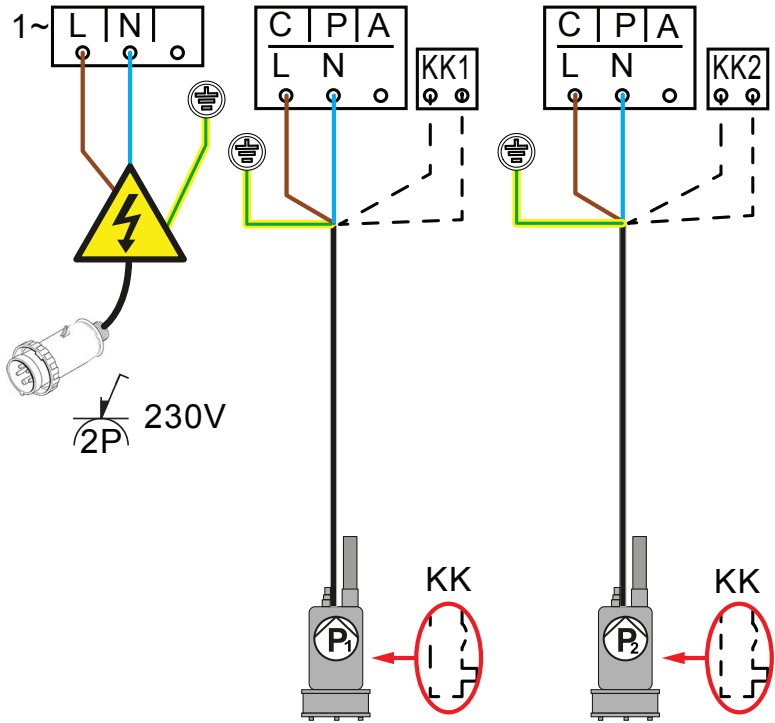
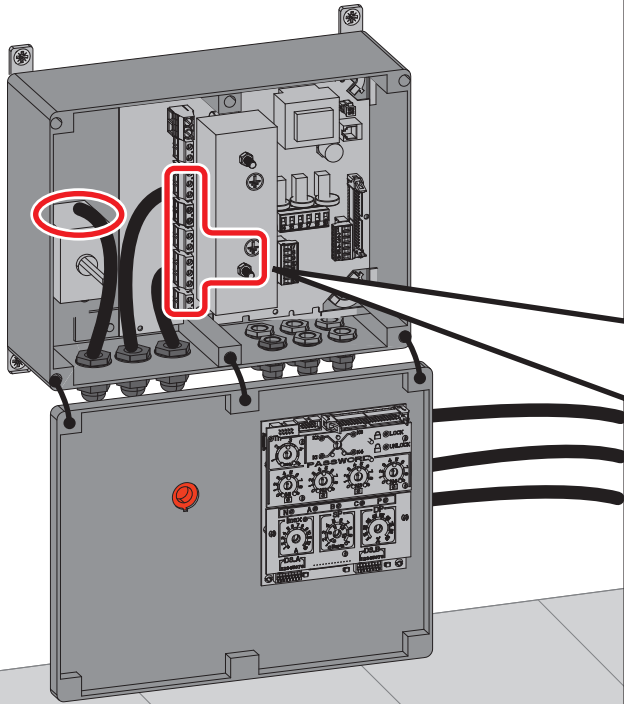
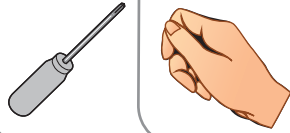

3b

# E.Box Basic

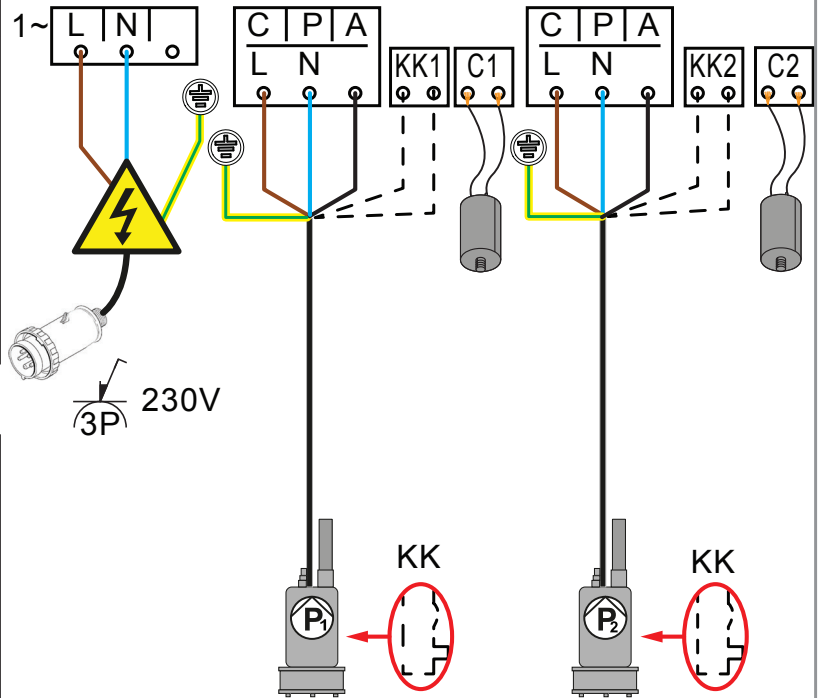
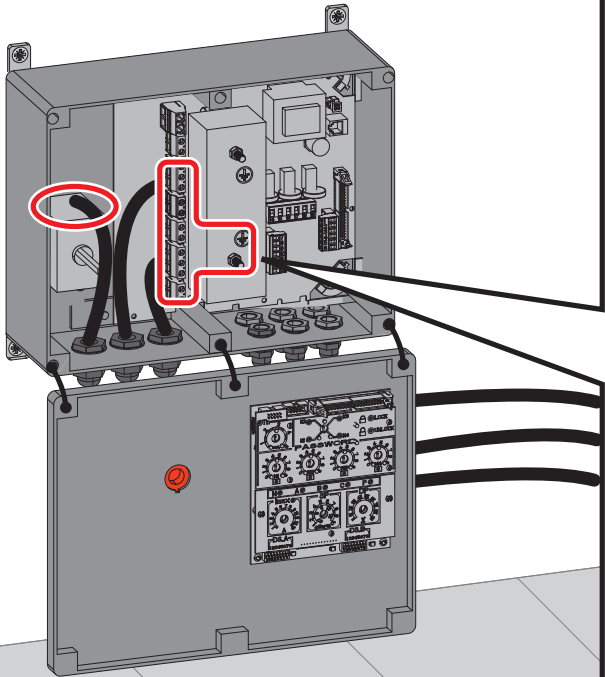
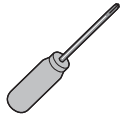

3c

# E.Box Plus

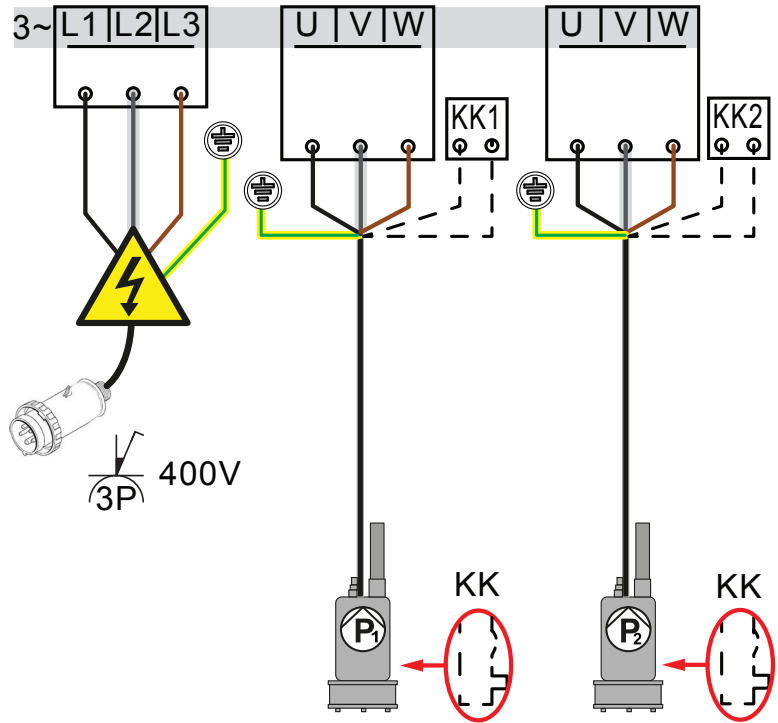
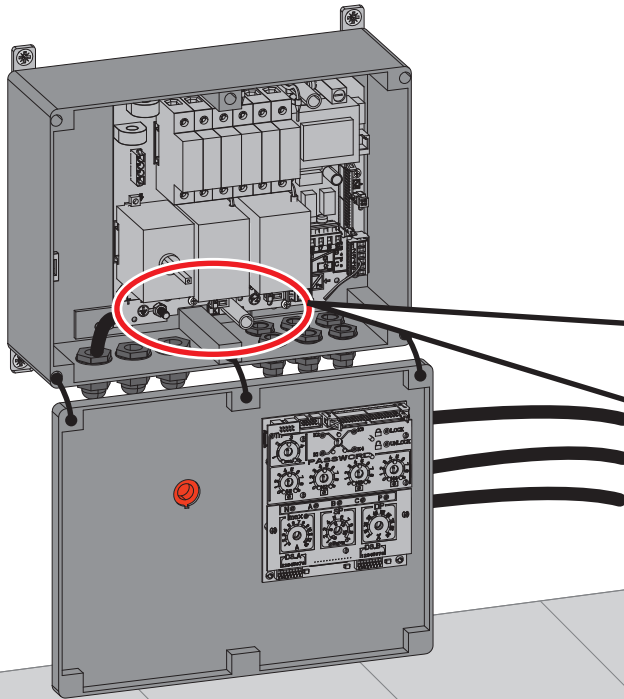
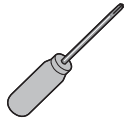

4

E.Box Plus D  
E.Box Basic D  
E.Box Plus  
E.Box Basic

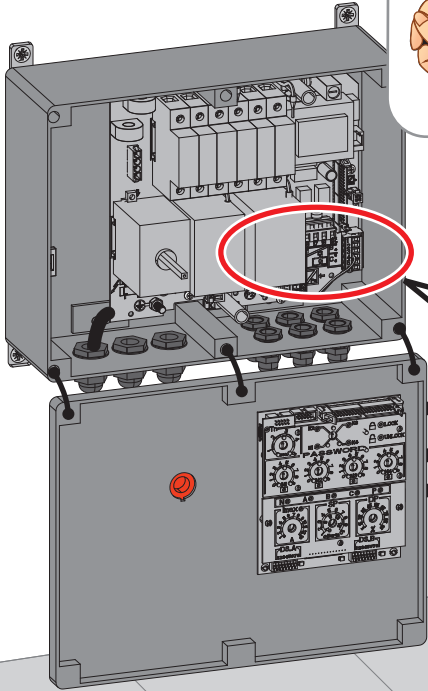
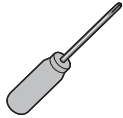

Q1



Q2



Q3

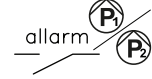

OPT.

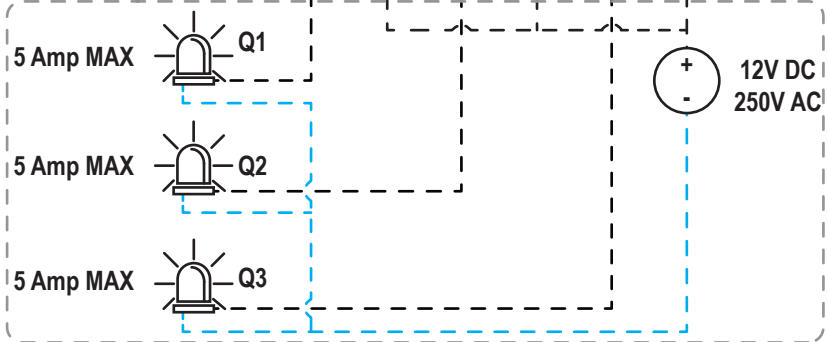
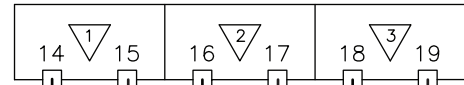

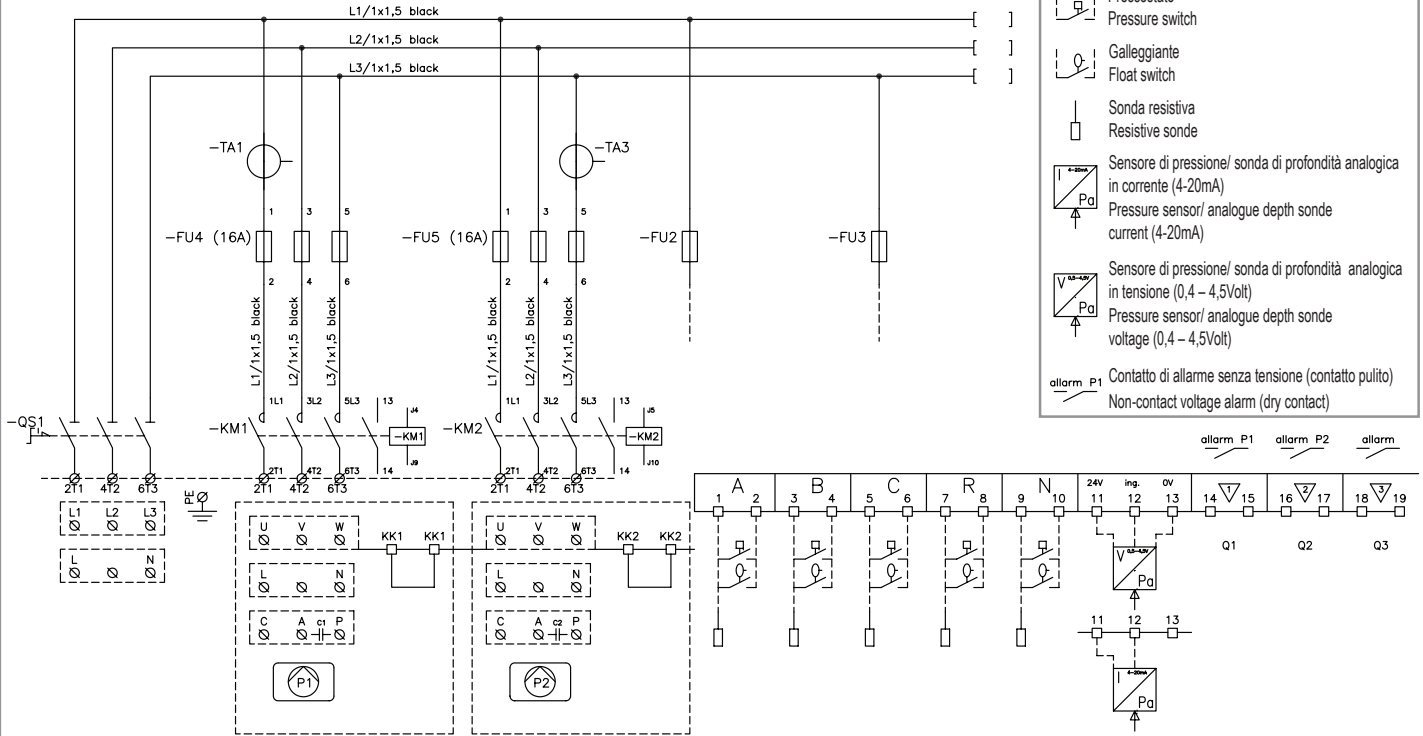



6

**DISPLAY**  
E.Box Plus D  
E.Box Basic D

**NO DISPLAY**  
E.Box Plus  
E.Box Basic

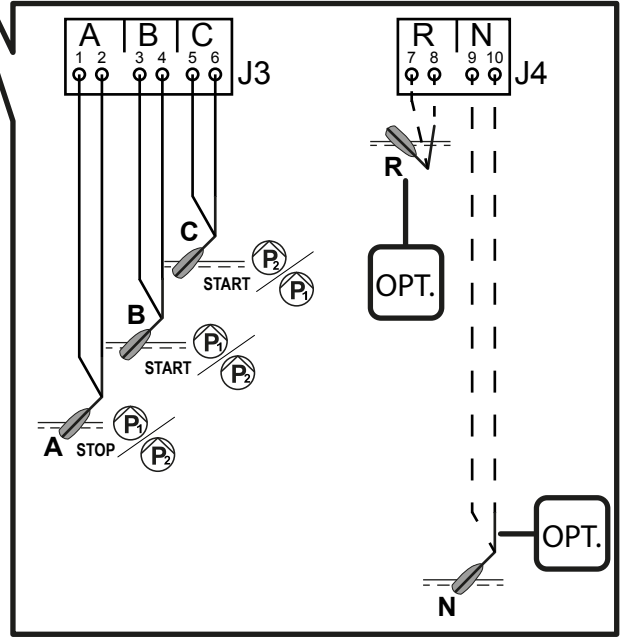
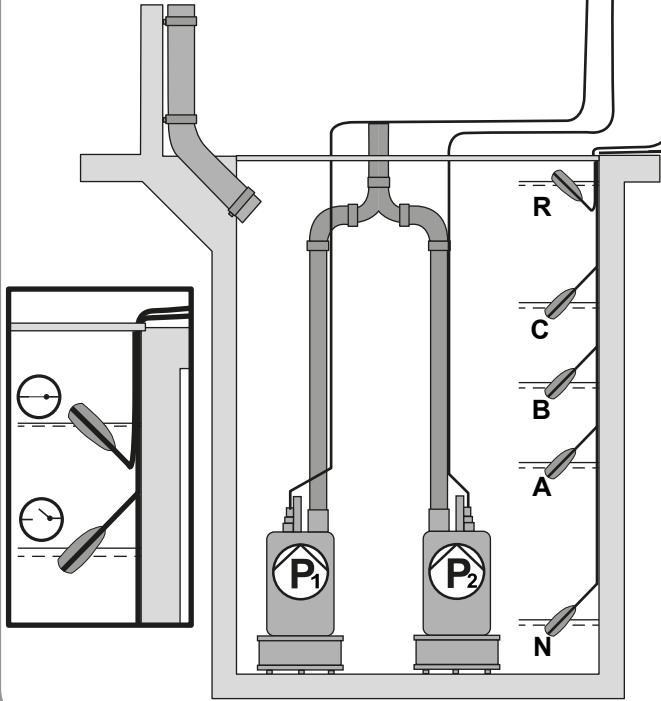
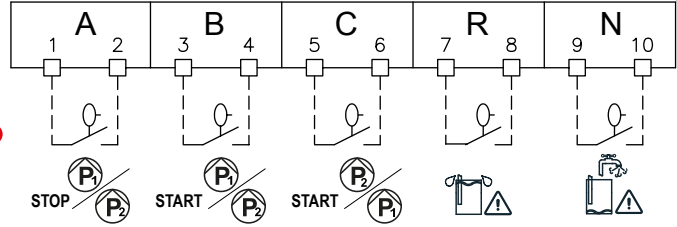
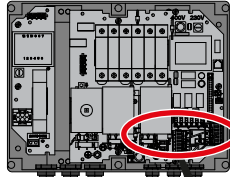



**7** **DISPLAY**  
E.Box Plus D  
E.Box Basic D

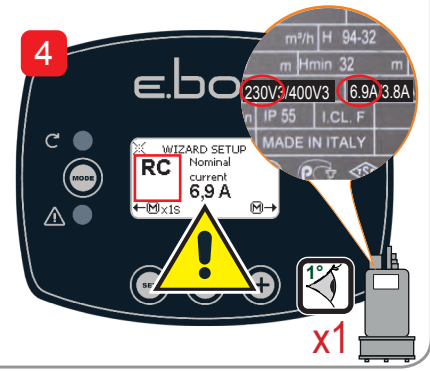
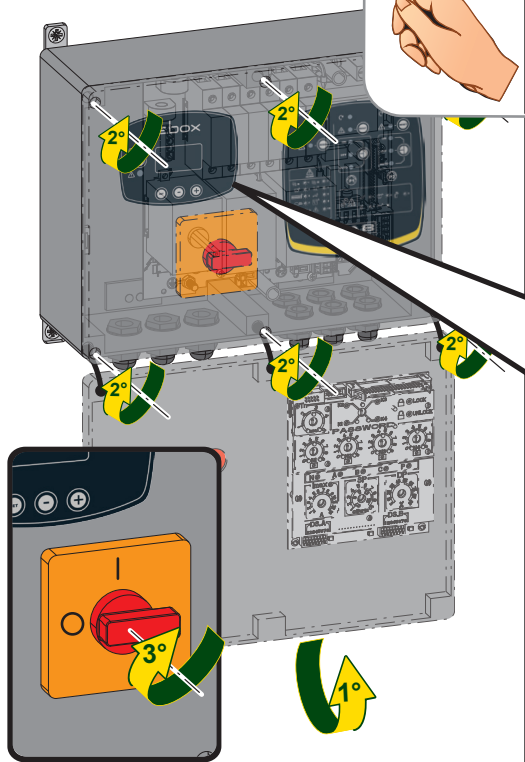
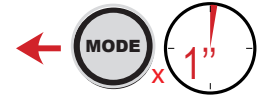
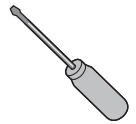

x1

**DISPLAY**  
E.Box Plus D  
E.Box Basic D



**RESTART WIZARD SETUP**

1

6

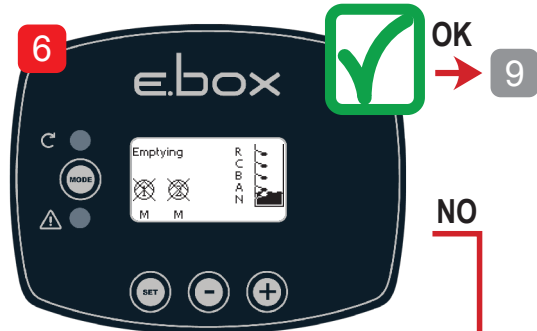

NO

9

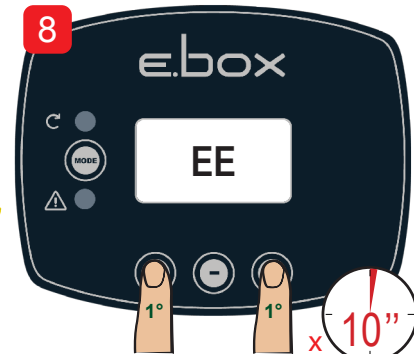
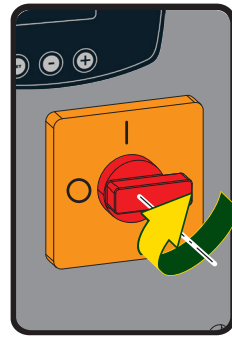
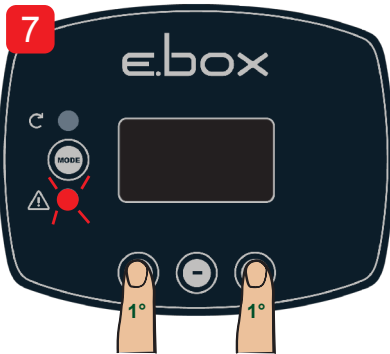
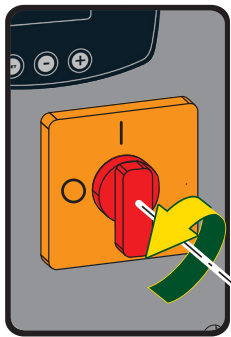



7 NO DISPLAY  
E.Box Plus  
E.Box Basic

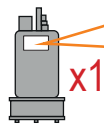
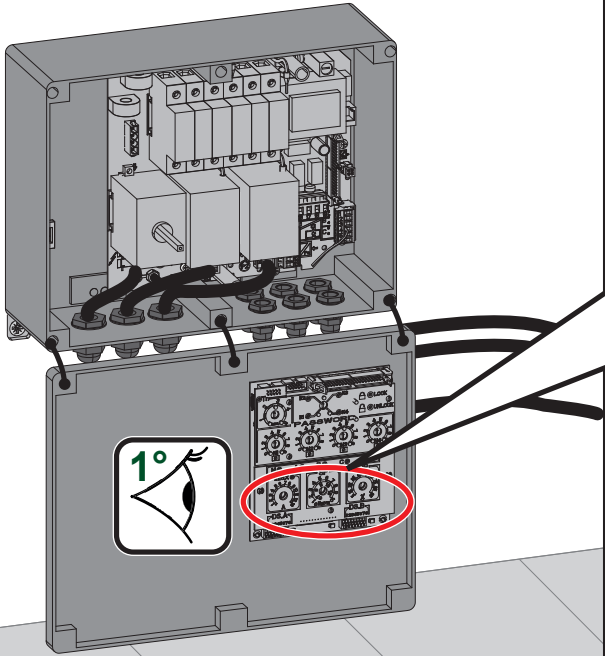
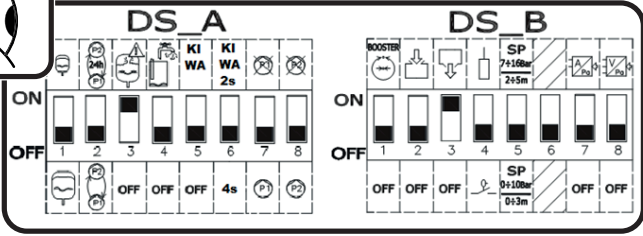
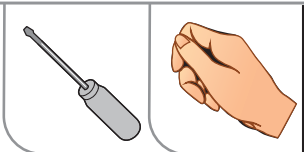

Imax

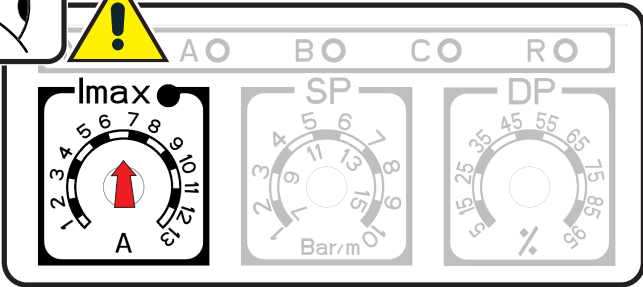

8

**NO DISPLAY**  
E.Box Plus  
E.Box Basic

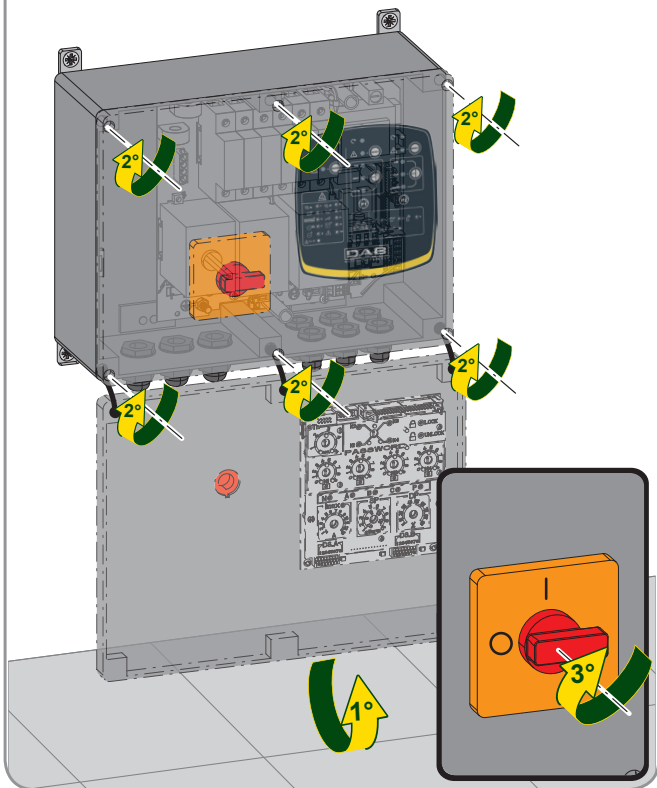
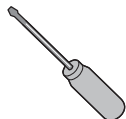

9

**DISPLAY**  
E.Box Plus D  
E.Box Basic D

**NO DISPLAY**  
E.Box Plus  
E.Box Basic

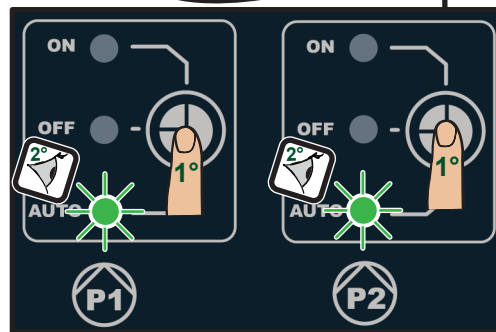
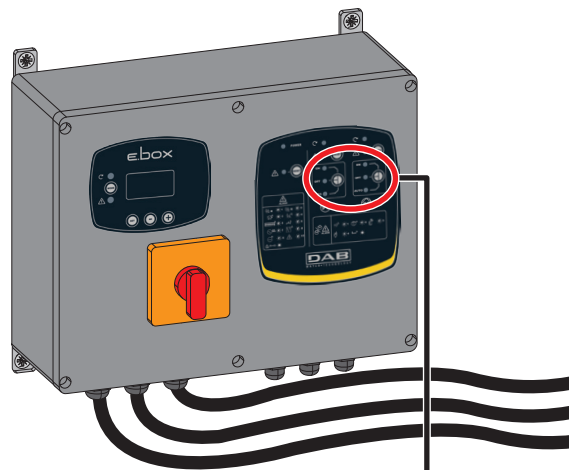

10

**DISPLAY**  
E.Box Plus D  
E.Box Basic D

**NO DISPLAY**  
E.Box Plus  
E.Box Basic

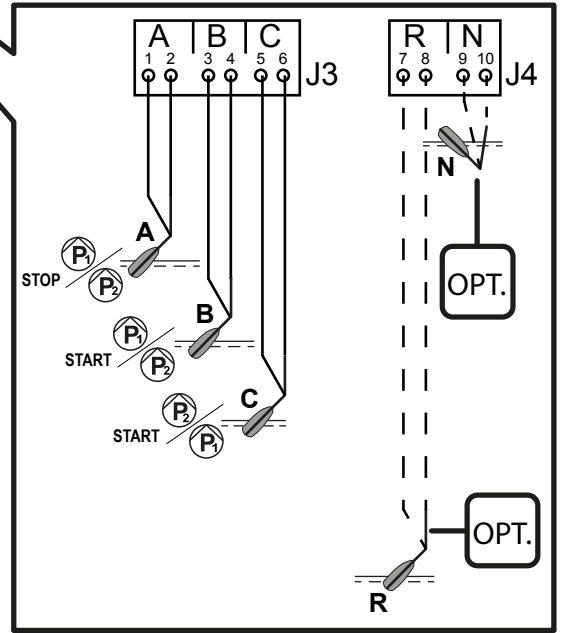
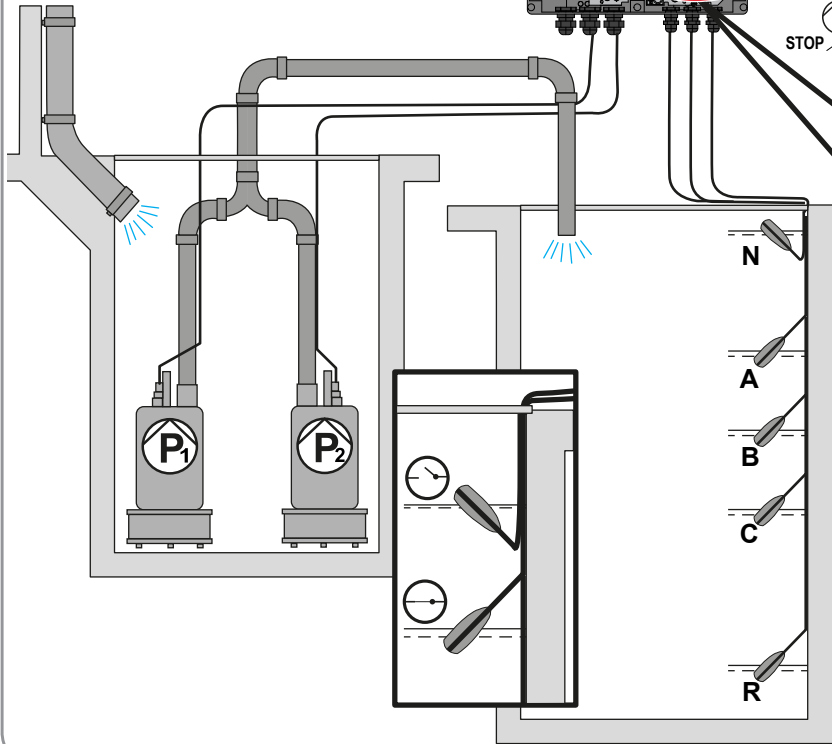
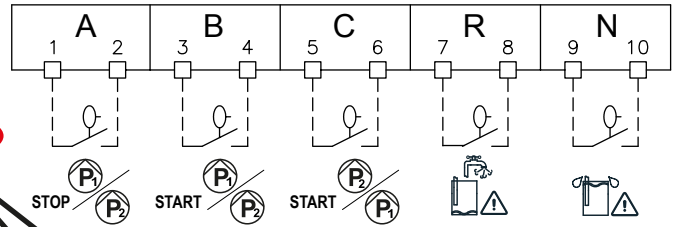
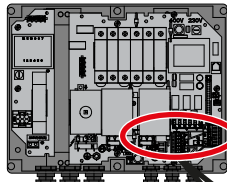

11

**DISPLAY**  
E.Box Plus D  
E.Box Basic D

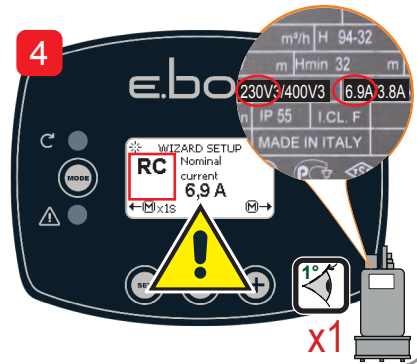
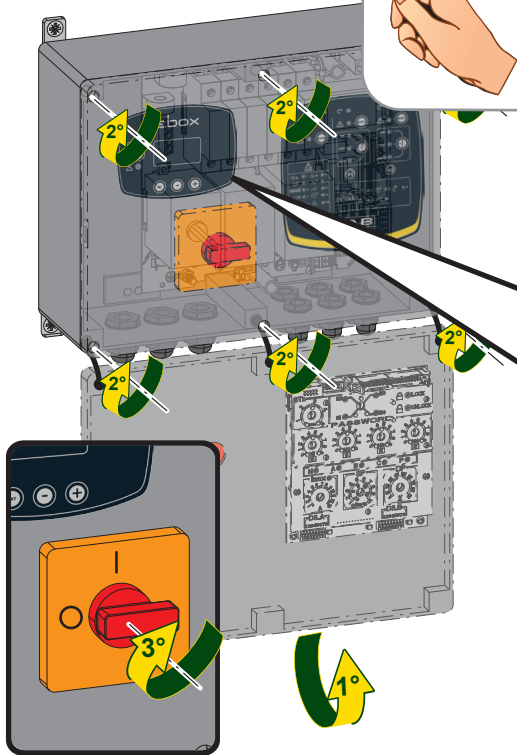
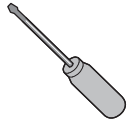

12

**DISPLAY**  
E.Box Plus D  
E.Box Basic D

### 1 RESTART WIZARD SETUP

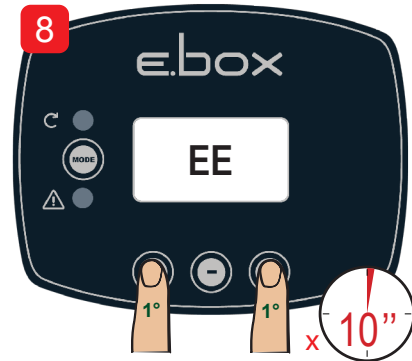
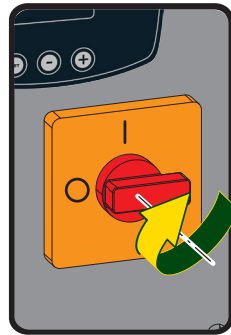
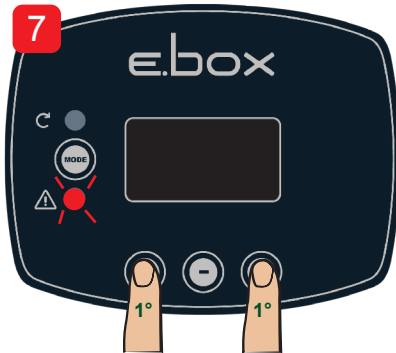
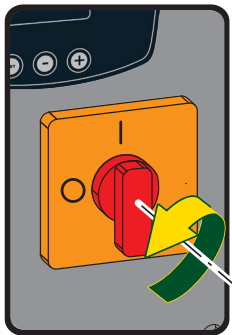



11

**NO DISPLAY**  
E.Box Plus  
E.Box Basic

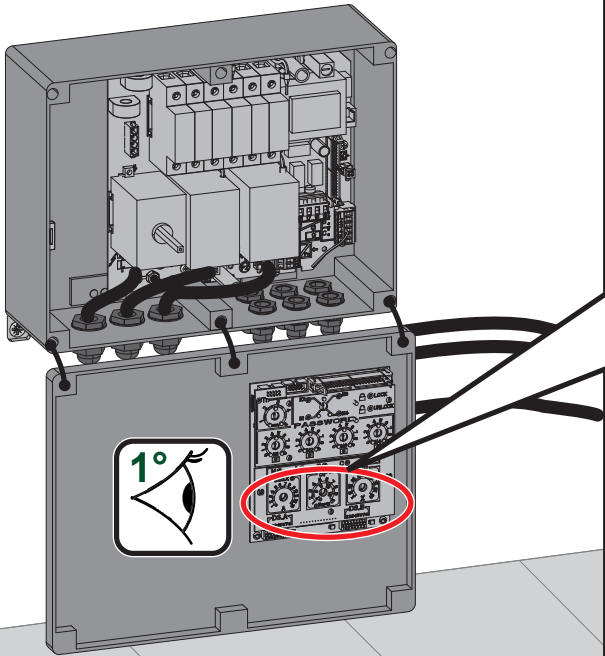
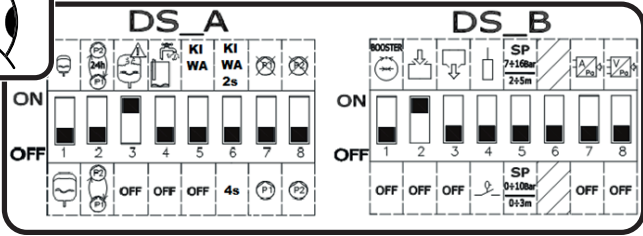
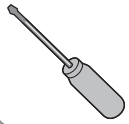

x1



Imax

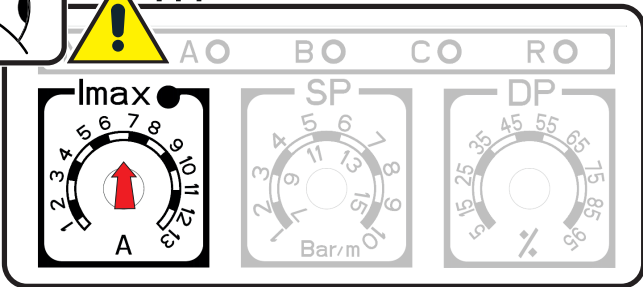

12 NO DISPLAY  
E.Box Plus  
E.Box Basic

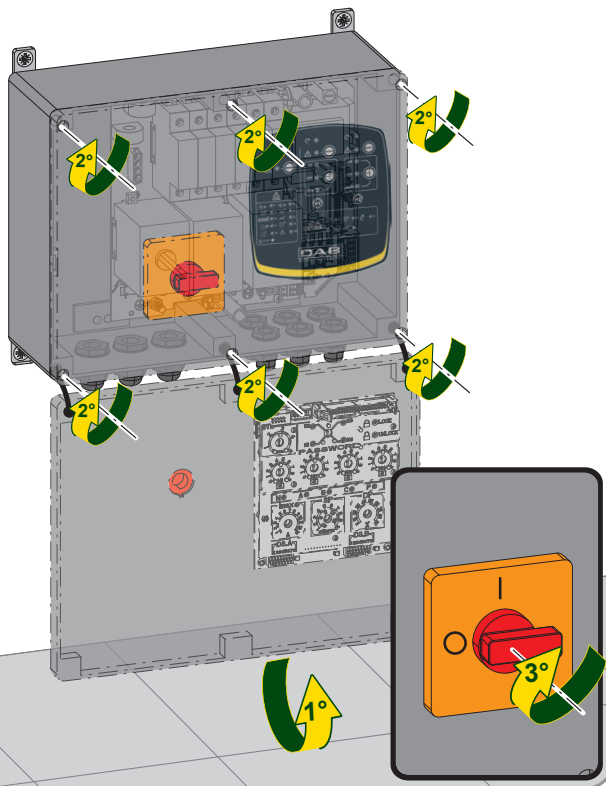
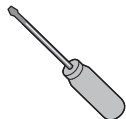

13 DISPLAY  
E.Box Plus D  
E.Box Basic D

NO DISPLAY  
E.Box Plus  
E.Box Basic

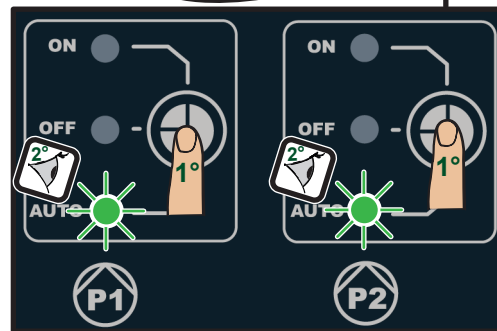
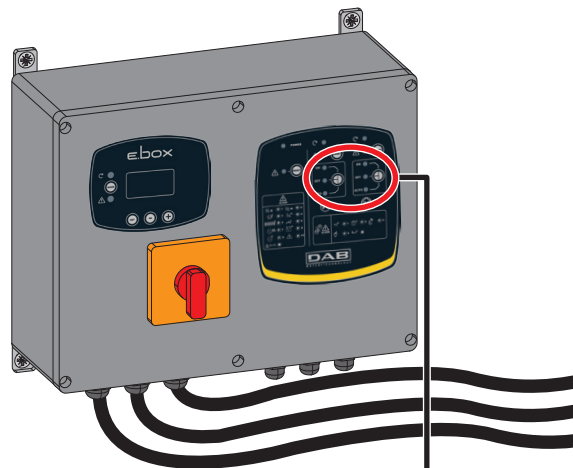

14

**DISPLAY**  
E.Box Plus D  
E.Box Basic D

**NO DISPLAY**  
E.Box Plus  
E.Box Basic

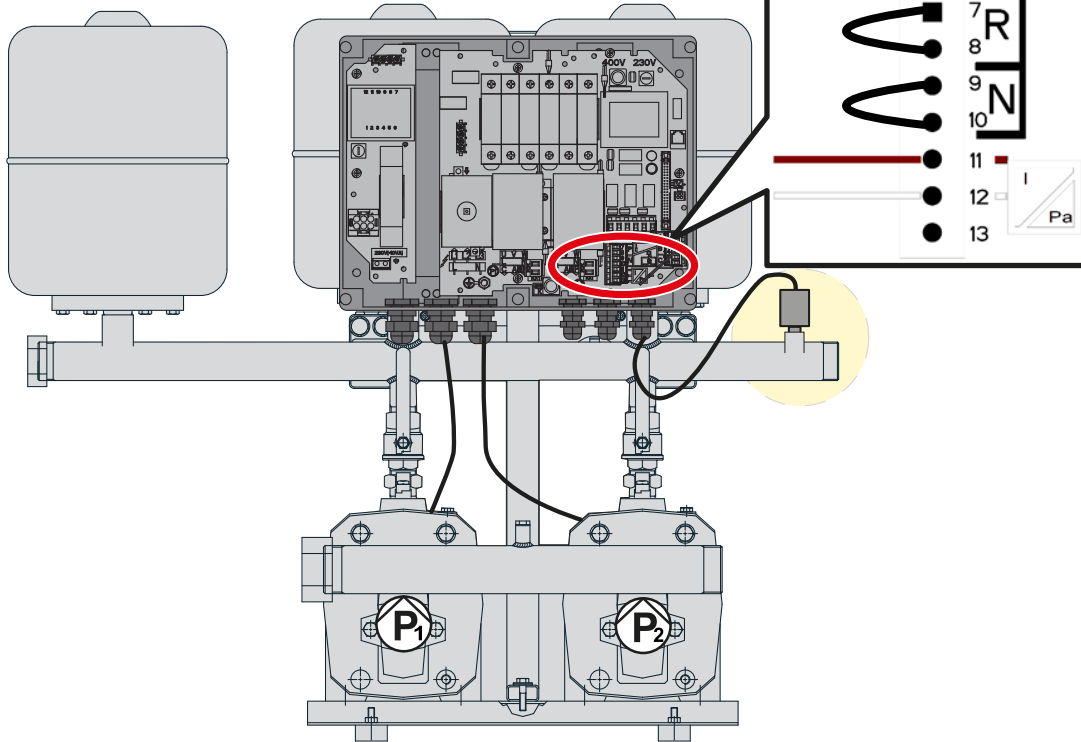

15

**DISPLAY**  
**E.Box Plus D**  
**E.Box Basic D**

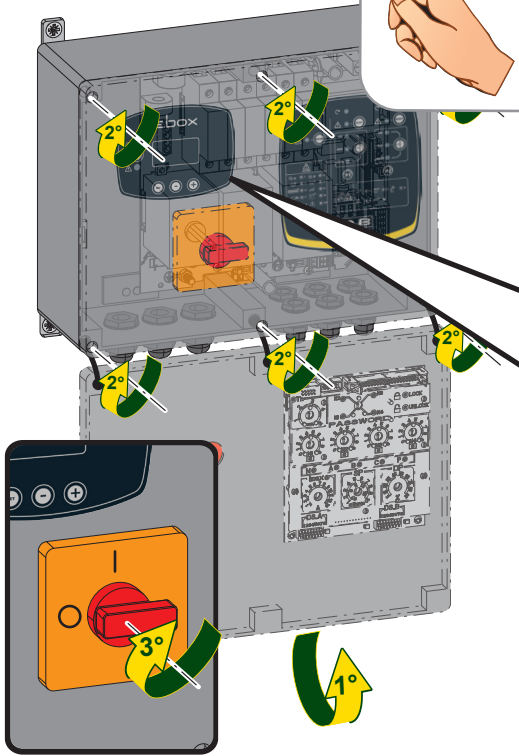
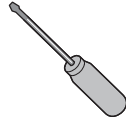

**DISPLAY**  
**E.Box Plus D**  
**E.Box Basic D**

**1** ← **RESTART WIZARD SETUP**

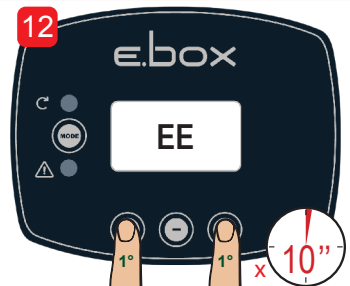
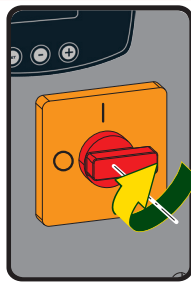
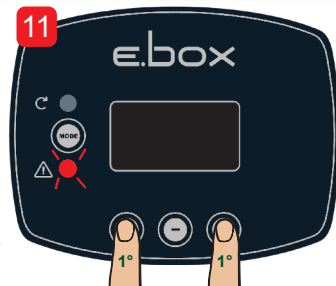
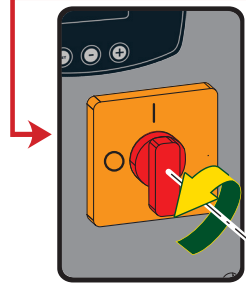
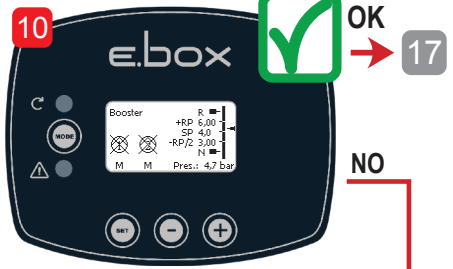
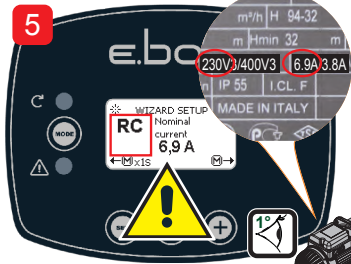

15

**NO DISPLAY**  
**E.Box Plus**  
**E.Box Basic**

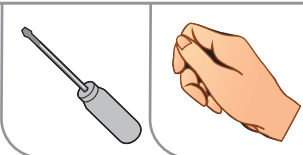

| DS_A |     |     |     |    |     |     |     | DS_B |     |     |     |     |     |     |     |
|------|-----|-----|-----|----|-----|-----|-----|------|-----|-----|-----|-----|-----|-----|-----|
| ON   | OFF | ON  | OFF | ON | OFF | ON  | OFF | ON   | OFF | ON  | OFF | ON  | OFF | ON  | OFF |
| 1    | 2   | 3   | 4   | 5  | 6   | 7   | 8   | 1    | 2   | 3   | 4   | 5   | 6   | 7   | 8   |
| OFF  | OFF | OFF | OFF | 4s | OFF | OFF | OFF | OFF  | OFF | OFF | OFF | OFF | OFF | OFF | OFF |

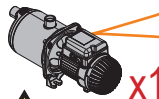
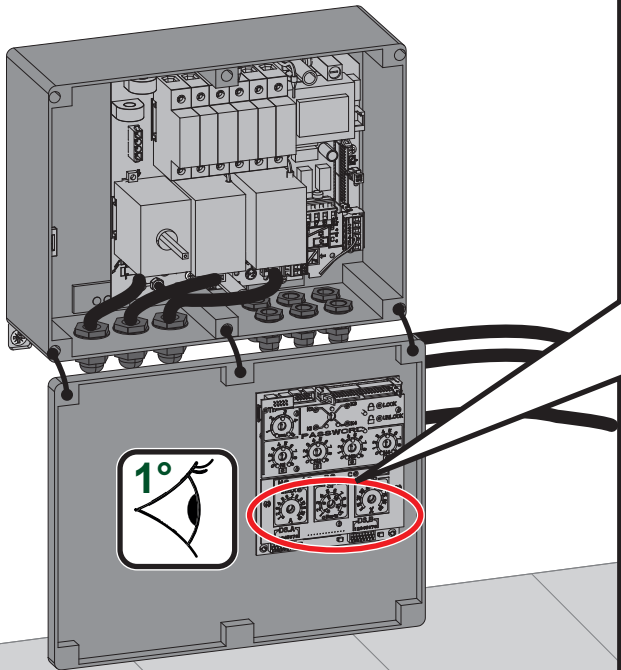

**Imax**

| AO                       | BO                         | CO                     | RO |
|--------------------------|----------------------------|------------------------|----|
| <p><b>Imax</b><br/>A</p> | <p><b>SP</b><br/>Bar/m</p> | <p><b>DP</b><br/>%</p> |    |

16

**NO DISPLAY**  
E.Box Plus  
E.Box Basic

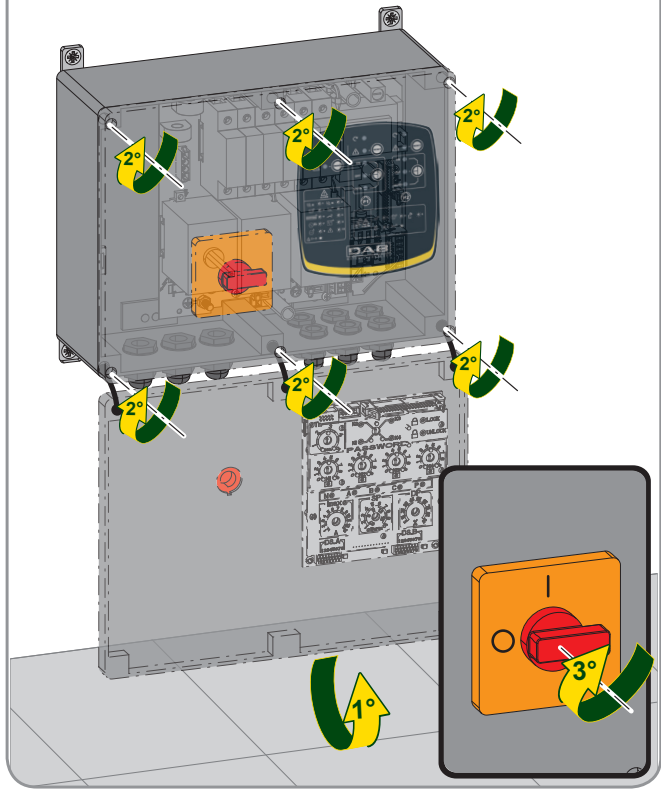
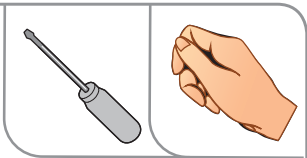

17

**DISPLAY**  
E.Box Plus D  
E.Box Basic D

**NO DISPLAY**  
E.Box Plus  
E.Box Basic

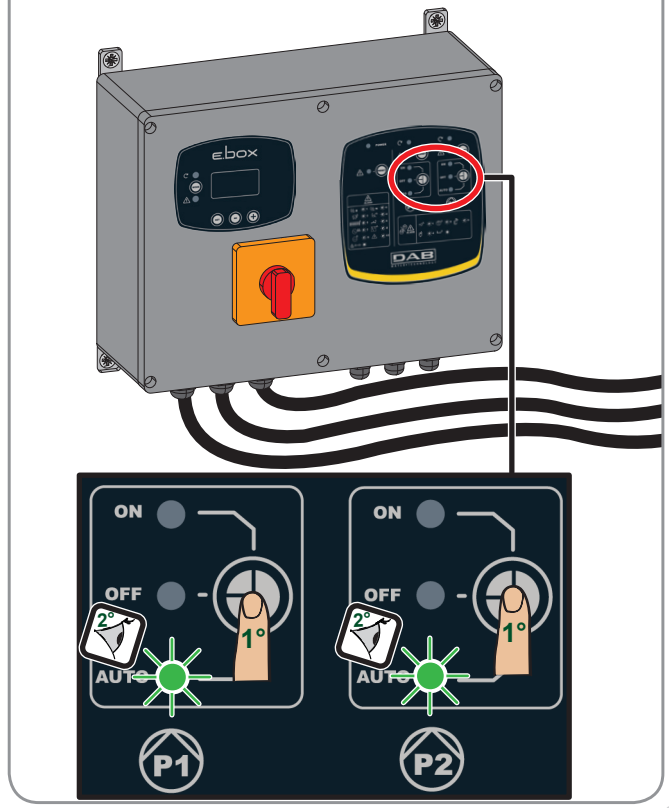

**DAB PUMPS LTD.**

6 Gilbert Court  
Newcomen Way  
Severalls Business Park  
Colchester  
Essex  
C04 9WN - UK  
salesuk@dwtgroup.com  
Tel. +44 0333 777 5010

**DAB PUMPS B.V.**

Albert Einsteinweg, 4  
5151 DL Drunen - Nederland  
info.netherlands@dwtgroup.com  
Tel. +31 416 387280  
Fax +31 416 387299

**DAB PUMPS HUNGARY KFT.**

H-8800  
Nagykanizsa, Buda Ernő u.5  
Hungary  
Tel. +36 93501700

**DAB PUMPS OCEANIA PTY LTD**

426 South Gippsland Hwy,  
Dandenong South VIC 3175 – Australia  
info.oceania@dwtgroup.com  
Tel. +61 1300 373 677

**DAB PUMPS IBERICA S.L.**

Calle Verano 18-20-22  
28850 - Torrejón de Ardoz - Madrid Spain  
Info.spain@dwtgroup.com  
Tel. +34 91 6569545  
Fax: + 34 91 6569676

**DAB PUMPS INC.**

3226 Benchmark Drive  
Ladson, SC 29456 - USA  
info.usa@dwtgroup.com  
Tel. 1- 843-797-5002  
Fax 1-843-797-3366

**DAB PUMPS GmbH**

Am Nordpark 3  
41069 Mönchengladbach, Germany  
info.germany@dwtgroup.com  
Tel. +49 2161 47 388 0  
Fax +49 2161 47 388 36

**DAB PUMPS DE MÉXICO, S.A. DE C.V.**

Av Amsterdam 101 Local 4  
Col. Hipódromo Condesa,  
Del. Cuauhtémoc CP 06170  
Ciudad de México  
Tel. +52 55 6719 0493

**DAB PUMPS BV**

'tHofveld 6 C1  
1702 Groot Bijgaarden - Belgium  
info.belgium@dwtgroup.com  
Tel. +32 2 4668353

**DAB PUMPS SOUTH AFRICA**

Twenty One industrial Estate,  
16 Purlin Street, Unit B, Warehouse 4  
Olifantsfontein - 1666 - South Africa  
info.sa@dwtgroup.com  
Tel. +27 12 361 3997

**DAB PUMPS POLAND SP. z.o.o.**

Ul. Janka Muzykanta 60  
02-188 Warszawa - Poland  
polska@dabpumps.com.pl

**DAB PUMPS (QINGDAO) CO. LTD.**

No.40 Kaituo Road, Qingdao Economic &  
Technological Development Zone  
Qingdao City, Shandong Province - China  
PC: 266500  
sales.cn@dwtgroup.com  
Tel. +86 400 186 8280  
Fax +86 53286812210

**DAB PUMPS S.p.A.**

Via M. Polo, 14 - 35035 Mestrino (PD) - Italy  
Tel. +39 049 5125000 - Fax +39 049 5125950  
www.dabpumps.com